

BAXAXX1X10

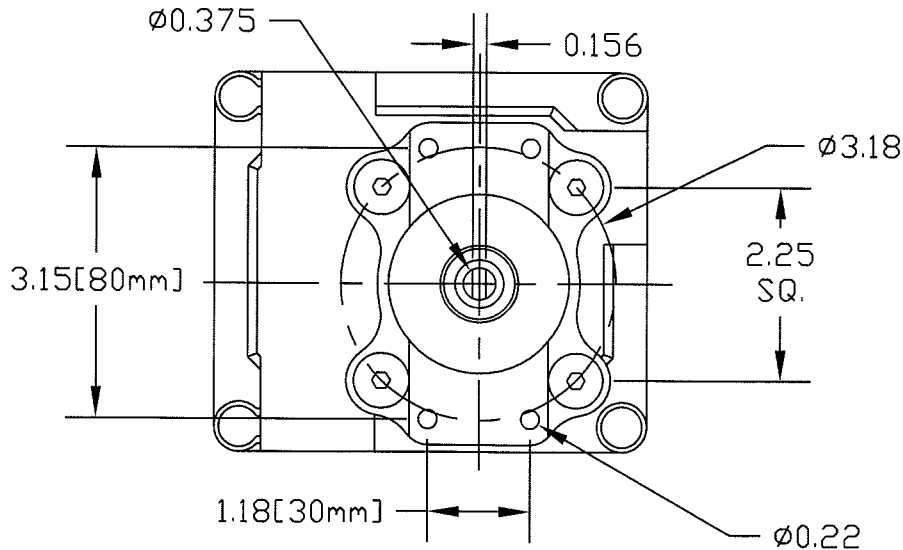
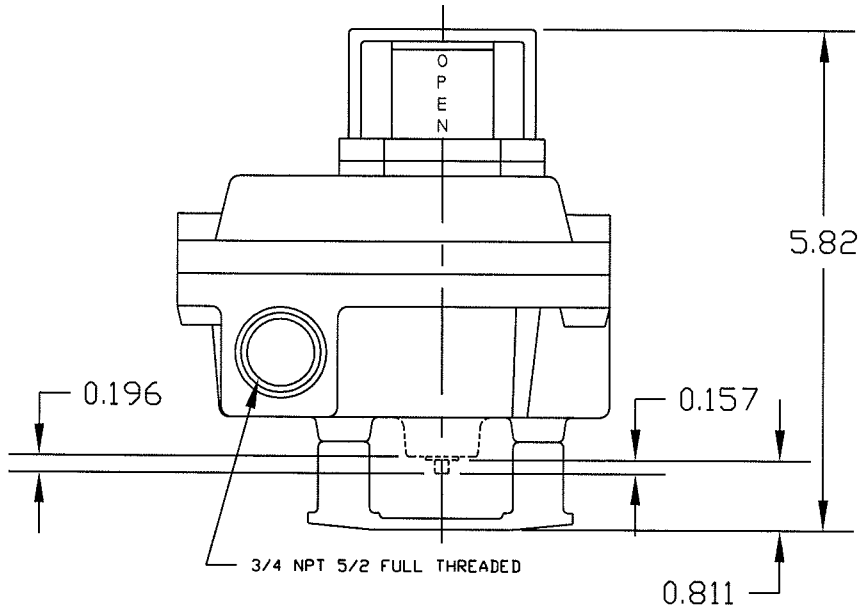
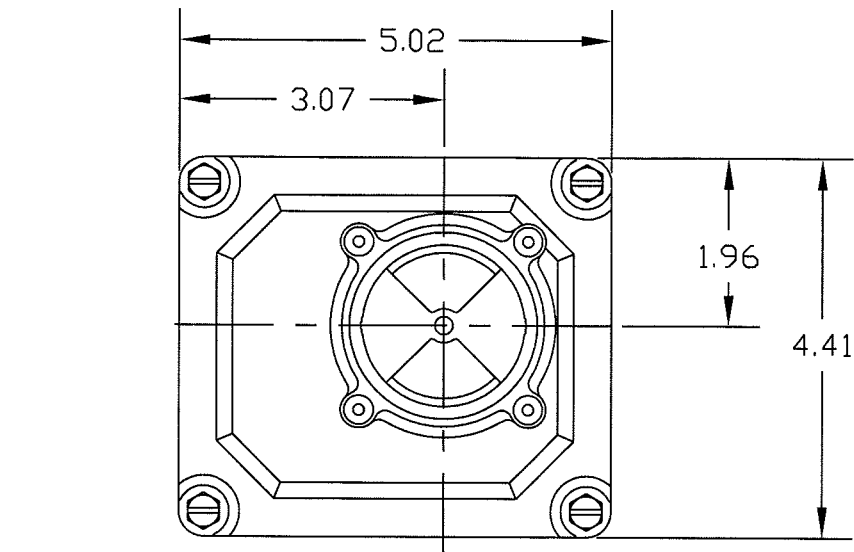

\* OPTIONS DO NOT INFLUENCE DIMENSIONS

SCALE 1:2

**SENITEC CORP**

NORCROSS, GEORGIA U.S.A. 30071

PRODUCT  
OUTLINE DRAWING

PART NUMBER  
BAXAXX1X10

DESCRIPTION

SENITEC  
POSITION INDICATING DEVICE  
NEMA 4 ALUMINUM  
NAMUR 80 X 20

SALES DRAWING NO.  
BAXAXX1X10

CLN REV.